

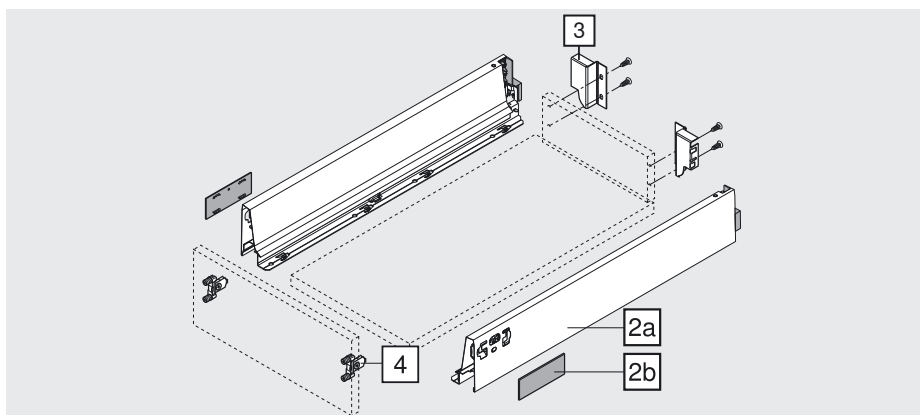

Informacje o zamawianiu

Szuflada standardowa – M



2a, 2b	Boki szuflady i zaślepka lewa/prawa		
	Warianty kolorów	SW TS RAL9006	
	Długość	Stal	Inox
	270 mm	358M2702SA	358M2702IA
	300 mm	358M3002SA	358M3002IA
	350 mm	358M3502SA	358M3502IA
	400 mm	358M4002SA	358M4002IA
	450 mm	358M4502SA	358M4502IA
	500 mm	358M5002SA	358M5002IA
	550 mm	358M5502SA	358M5502IA
	600 mm	359M6002SA	359M6002IA
	650 mm	359M6502SA	359M6502IA

3	Uchwyt ścianki tylnej lewy/prawy		
	Warianty kolorów	SW TS RAL9006	niklowany
		Stal	
		Z30M000S.04	

4	Mocowanie frontu		
	Wersja INSERTA	2x	ZSF.3902
	Wersja na wkręty	2x	ZSF.3502
	Wersja wciskana	2x	ZSF.3602

Strony ze wskazówkami	
Prowadnica TANDEMBOX	3

Informacje dotyczące planowania

Szuflada standardowa – M

Wymiary zabudowy w korpusie	Wymiary montażowe frontu	Wymiary montażowe ścianki tylnej	
	FA Nałożenie frontu		

Wymiary zabudowy
NL Długość

Wymiary przycięcia dla płyty wiórowej 16 mm	
	Ścianka tylna 84 mm
	Dno Drewniana ścianka tylna NL - 24 mm Stalowa ścianka tylna NL - 22 mm
	KB Szerokość korpusu
	LW Szerokość wewn. korpusu
	NL Długość

Informacje o zamawianiu

Prowadnica TANDEMBOX

Prowadnica korpusu lewa/prawa		BLUMOTION*			TIP-ON		
	Długość	30 kg	50 kg	65 kg	20 kg	30 kg	50 kg
	270 mm	558.2701B			559.2701T		
	300 mm	558.3001B			559.3001T		
	350 mm	558.3501B01				559.3501T	
	400 mm	558.4001B01				559.4001T	
	450 mm	558.4501B01	559.4501B	556.4501B			559.4501T
	500 mm	558.5001B	559.5001B	556.5001B			559.5001T
	550 mm	558.5501B	559.5501B	556.5501B			559.5501T
	600 mm		559.6001B	556.6001B			559.6001T
	650 mm		559.6501B	556.6501B			559.6501T

* Odpowiedni do SERVO-DRIVE

Montaż prowadnicy korpusu

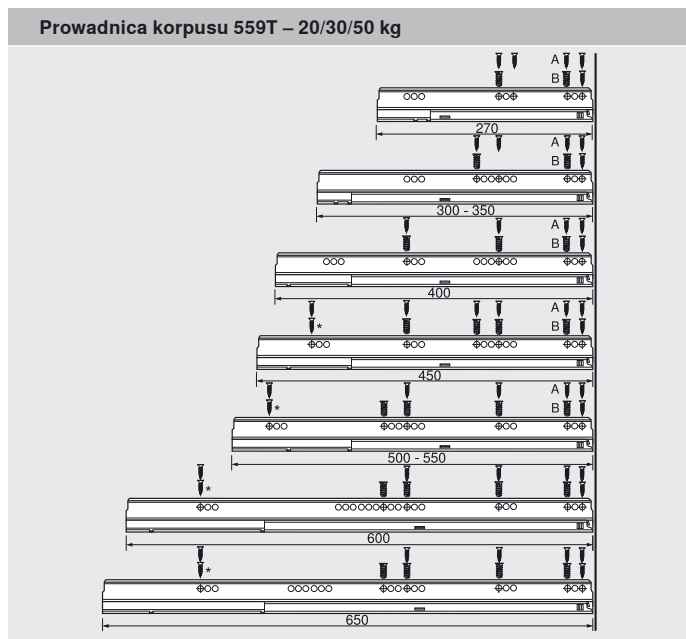
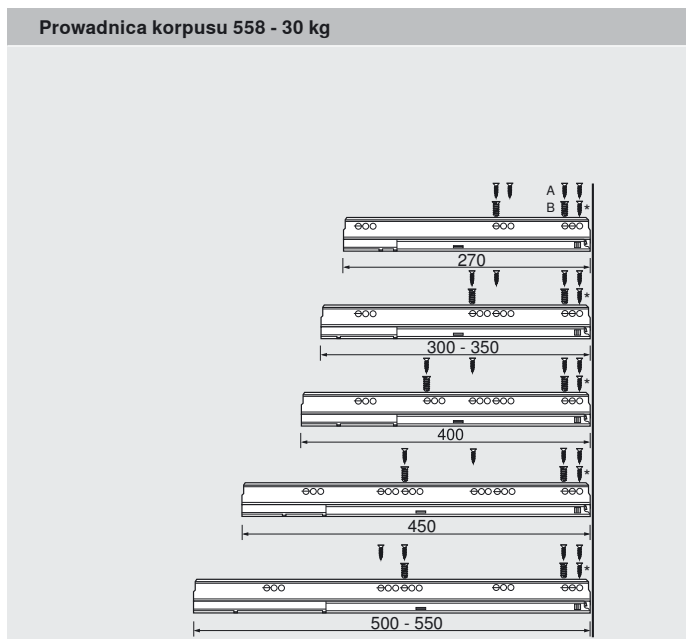
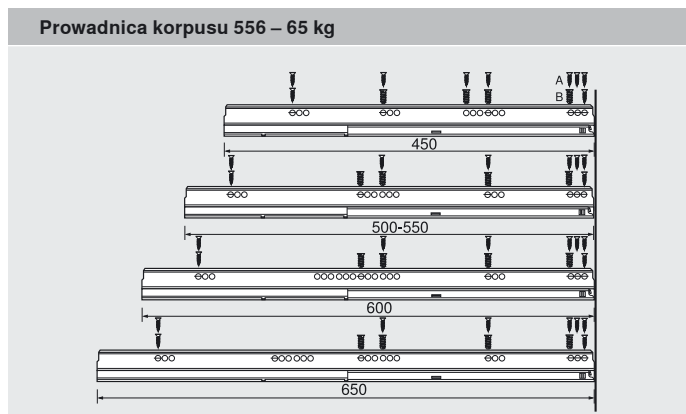
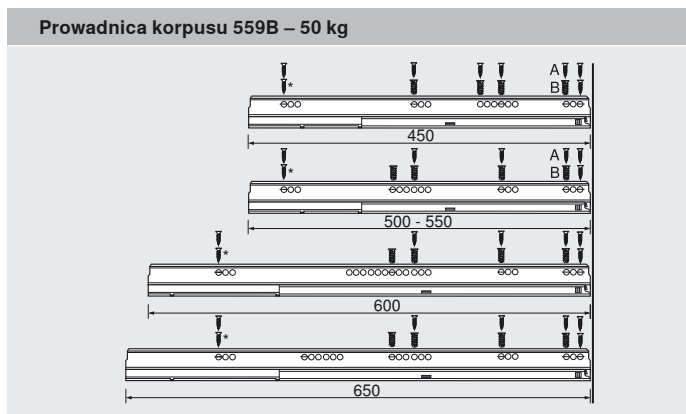

A Wkręt do płyty wiórowej Ø 4 x 15 mm

B Wkręt EURO

Nr art. 661.145